



## 3.0A Step Down Switching voltage Regulator

## LM2576

### Adjustable & Fix Output

#### Description

The Bay Linear LM2576 contains fixed and adjustable switching voltage regulators that require a minimum of external components. All circuitry necessary to build a buck-switching regulator is included.

The LM2576 is available in 3.3V; 5V, 12V & 15V fixed voltages, or an adjustable version with an output voltage range from 1.23V to 37V. The guaranteed accuracy for specified input and load conditions is  $\pm 4\%$ .

The LM2576 can supply 3A with an excellent load and line regulation. Protection such as cycle-by-cycle current limiting or thermal shutdown has been designed. In standby mode, the current consumption has been minimized (200 $\mu$ A).

For 1A step-down switching regulators refer to B2575 data sheets

#### Features

- **Guaranteed 3A Output Current**
- **High Efficiency**
- **Wide Input Voltage, up to 40V**
- **3.3V, 5V, 12V, 15V and Adjustable Output Versions**
- **Thermal Shutdown and Current Limit Protection**
- **Requires only 4 External Components**
- **Low Power Standby Mode < 200 $\mu$ A Typical**
- **Shutdown Capability (Standby Mode)**
- **52kHz Fixed Frequency Internal Oscillator**
- **Uses Standard Inductors**
- **Pin-to-Pin Compatible with LM2576**

#### Applications

- **Efficient Pre-Regulator for Linear Regulators**
- **On-card Switching Regulators**
- **Positive to Negative Converter (Buck-Boost)**
- **Simple High-efficiency Step-down (Buck)**
- **Portable Instruments**

#### Pin Connection

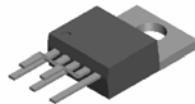

#### Ordering Information

Devices	Package	Temp.
LM2576T-X	TO-220	-40 °C to 125 °C
LM2576S-X	TO-263	-40°C to 125 °C
LM2576J-X	LPDD	-40°C to 125 °C

X= Output Voltage (X=3.3V, 5.0V, 12V, 15V or Blank for Adjustable)  
Consult factory for other fixed voltages.

TO-263-5 Package

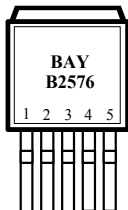

Top View

- 1)  $V_{IN}$
- 2)  $V_{OUT}$
- 3) GND
- 4) FB
- 5)  $\overline{ON/OFF}$

TO-220-5 Package



Top View

- 1)  $V_{IN}$
- 2)  $V_{OUT}$
- 3) GND
- 4) FB
- 5)  $\overline{ON/OFF}$

## Absolute Maximum Rating

Parameter	Symbol	Value	Unit
Maximum Input Voltage	$V_{IN}$	45	V
Power Dissipation	$P_O$	Internally Limited	W
Off Pin Input Voltage		$-0.3V < V < V_{IN}$	
Output Voltage		-1	V
Supply Voltage		40	V
Operating Junction Temperature Range Control Section Power Transistor	$T_J$	$-40 < T_J < 85$	°C
Storage Temperature Range	$T_{STG}$	-65 to 150	
Lead Temperature (Soldering 10 Sec.)	$T_{LEAD}$	260	

**ELECTRICAL CHARACTERISTICS**  $T_A = 25^\circ\text{C}$   $V_{IN} = 12\text{V}$ ,  $I_{LOAD} = 100\text{mA}$  unless otherwise specified.

**Boldface** type applies over full Operating Temperature Range.

Parameter	Conditions	LM2576			Units
		Typ	Min	Max	
<b>Adjustable Regulators (Note 3)(Note 8)</b>					
Output Voltage ( $V_{OUT}$ )	$V_{IN} = 12\text{V}$ , $I_{LOAD} = 0.5\text{A}$ , $V_{OUT} = 5\text{V}$	1.230	1.217	1.243	V
	$0.5\text{A} \leq I_{LOAD} \leq 3\text{A}$ , $6\text{V} \leq V_{IN} \leq 40\text{V}$ , $V_{OUT} = 5\text{V}$	1.230 <b>1.230</b>	1.193 <b>1.180</b>	1.267 <b>1.280</b>	V
Efficiency (Note 7)	$V_{IN} = 12\text{V}$ , $I_{LOAD} = 3\text{A}$ , $V_{OUT} = 5\text{V}$	82			%
<b>3.3V Version (Note 3)(Note 9)</b>					
Output Voltage ( $V_{OUT}$ )	$V_{IN} = 12\text{V}$ , $I_{LOAD} = 0.5\text{A}$ , $V_{OUT} = 3.3\text{V}$	3.3	3.234	3.366	V
	$0.5\text{A} \leq I_{LOAD} \leq 3\text{A}$ , $6\text{V} \leq V_{IN} \leq 40\text{V}$ , $V_{OUT} = 3.3\text{V}$	3.3 <b>3.3</b>	3.168 <b>3.135</b>	3.432 <b>3.465</b>	V
Efficiency	$V_{IN} = 12\text{V}$ , $I_{LOAD} = 3\text{A}$	75			%
<b>5V Version (Note 3)(Note 9)</b>					
Output Voltage ( $V_{OUT}$ )	$V_{IN} = 12\text{V}$ , $I_{LOAD} = 0.5\text{A}$ , $V_{OUT} = 5\text{V}$	5.0	4.900	5.100	V
	$0.5\text{A} \leq I_{LOAD} \leq 3\text{A}$ , $8\text{V} \leq V_{IN} \leq 40\text{V}$ , $V_{OUT} = 5\text{V}$	5.0 <b>5.0</b>	4.800 <b>4.750</b>	5.200 <b>5.250</b>	V
Efficiency (Note 7)	$V_{IN} = 12\text{V}$ , $I_{LOAD} = 3\text{A}$ , $V_{OUT} = 5\text{V}$	82			%
<b>12V Version (Note 3)(Note 9)</b>					
Output Voltage ( $V_{OUT}$ )	$V_{IN} = 25\text{V}$ , $I_{LOAD} = 0.5\text{A}$ , $V_{OUT} = 12\text{V}$	12	11.760	12.240	V
	$0.5\text{A} \leq I_{LOAD} \leq 3\text{A}$ , $15\text{V} \leq V_{IN} \leq 40\text{V}$ , $V_{OUT} = 12\text{V}$	12 <b>12</b>	11.520 <b>11.400</b>	12.480 <b>12.600</b>	V
Efficiency (Note 7)	$V_{IN} = 25\text{V}$ , $I_{LOAD} = 3\text{A}$	88			%
<b>15V Version (Note 3)(Note 9)</b>					
Output Voltage ( $V_{OUT}$ )	$V_{IN} = 30\text{V}$ , $I_{LOAD} = 0.5\text{A}$ , $V_{OUT} = 15\text{V}$	15	14.700	15.300	V
	$0.5\text{A} \leq I_{LOAD} \leq 3\text{A}$ , $18\text{V} \leq V_{IN} \leq 40\text{V}$ , $V_{OUT} = 15\text{V}$	15 <b>15</b>	14.400 <b>14.250</b>	15.600 <b>15.750</b>	V
Efficiency (Note 7)	$V_{IN} = 30\text{V}$ , $I_{LOAD} = 3\text{A}$	88			%

**ELECTRICAL CHARACTERISTICS**  $T_A = 25^\circ\text{C}$   $V_{IN} = 12\text{V}$ ,  $I_{LOAD} = 100\text{mA}$  unless otherwise specified.  
**Boldface type applies over full Operating Temperature Range.**

Parameters	Conditions	Typ	LM2576 Min	Max	Units
<b>Adjustable Regulator</b>					
Feedback Bias Current	$V_{OUT} = 5\text{V}$	50		100 <b>500</b>	nA
<b>Fixed and Adjustable Regulators</b>					
Oscillator Frequency		52	47 <b>42</b>	58 <b>63</b>	kHz
Saturation Voltage	$I_{OUT} = 0.5\text{A}$ , (Note 4)	1.4		1.8 <b>2.0</b>	V
Max Duty Cycle	(Note 5)	98	93		%
Current Limit	Peak Current, $t_{ON} \leq 3\mu\text{s}$ , (Note 4)	5.8	4.2 <b>3.5</b>	6.9 <b>7.5</b>	A
Output Leakage Current	$V_{IN}$ , (Note 6), Output = 0V (Note 6), Output = -1V	7.5		2 30	mA
Quiescent Current	(Note 6)	5		10	mA
Standby Quiescent Current	ON/OFF Pin = 5V (OFF)	50		200	$\mu\text{A}$
Thermal Resistance	$T_J, U$ package, Junction to Ambient, (Note 7) $T_J, U$ package, Junction to case	65 2			$^\circ\text{C}/\text{W}$
<b>ON/OFF Control, Fixed &amp; Adjustable Regulators (Note 8) (Note9)</b>					
OFF Input Level	$V_{OUT} = 0\text{V}$	1.4	2.2 <b>2.4</b>		V
ON Input Level	$V_{OUT} = 15\text{V}$ or 5V	1.2		1.0 <b>0.8</b>	V
OFF Logic Current	ON/OFF Pin = 5V (OFF)	4		30	$\mu\text{A}$
ON Logic Current	ON/OFF Pin = 0V (ON)	0.01		10	$\mu\text{A}$

Note 1: **Absolute Maximum Ratings** indicate limits beyond which damage to the device may occur. Operating Ratings indicate test conditions for which the device is intended to be functional, but do not guarantee specific performance limits. For guaranteed specifications and test conditions see the Electrical Characteristics.

Note 2: All limits guaranteed at room temperature (standard type face) and at **temperature extremes (bold type face)**. All room temperature limits are 100% production tested. All limits at **temperature extremes** are guaranteed via testing.

Note 3: External components such as the diode, inductor and capacitor can affect the system performance.

Note 4: Output (pin 2) sourcing current. No diode, inductor, or capacitor connected to input.

Note 5: Feedback (pin 4) removed from output and connected to 0V.

Note 6: Feedback (pin 4) removed from output and connected to 12V to force the output transistor OFF.

Note 7: Junction to ambient thermal resistance with approximately 1 square inches of PC board cooper surrounding the leads.

Note 8: Test circuit refers to figure 2.

Note 9: Test circuit refers to figure 3.

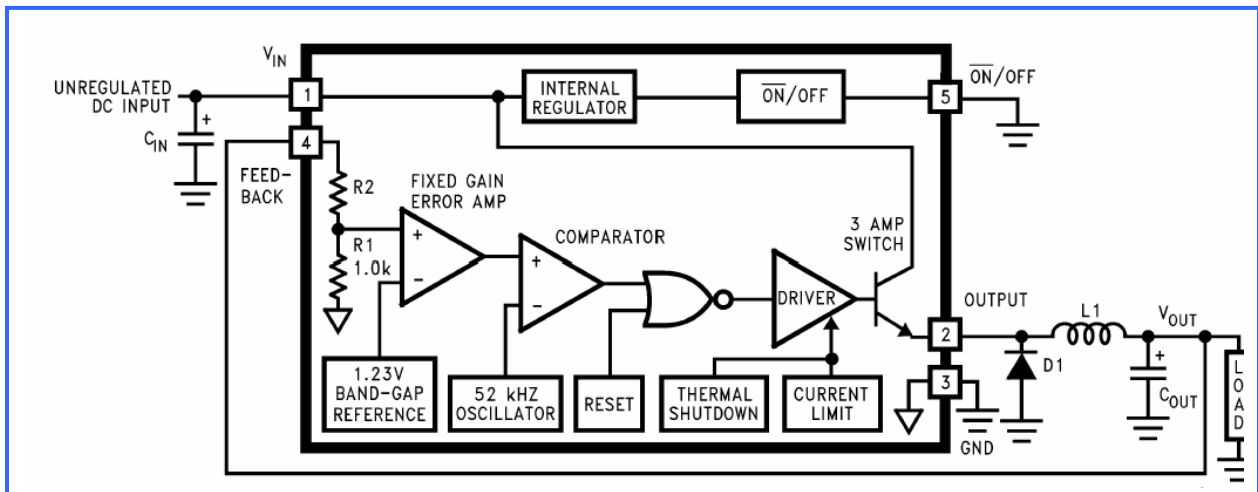

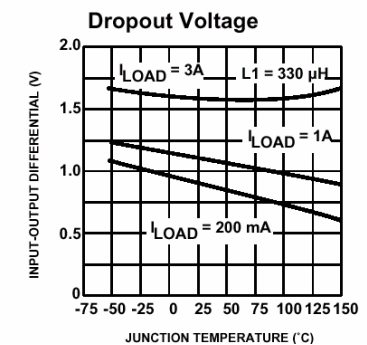
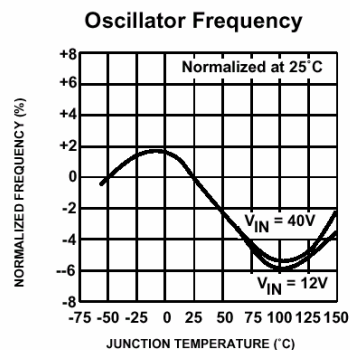
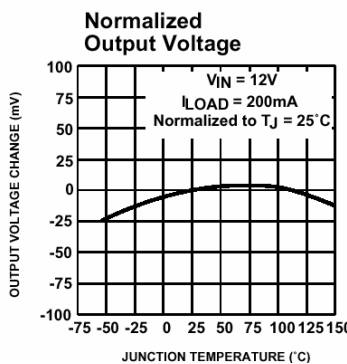
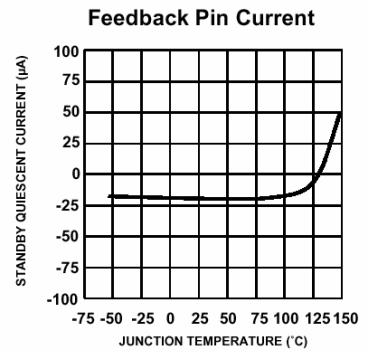
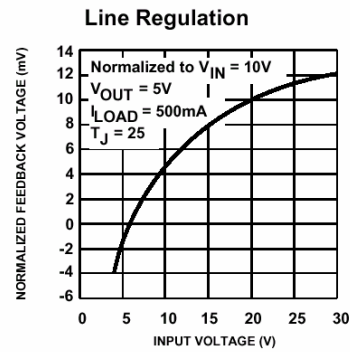
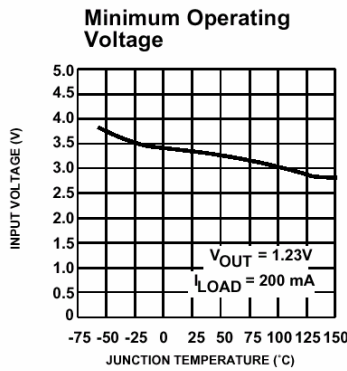
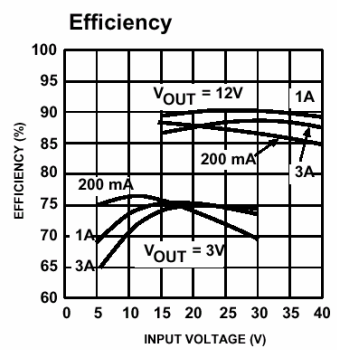
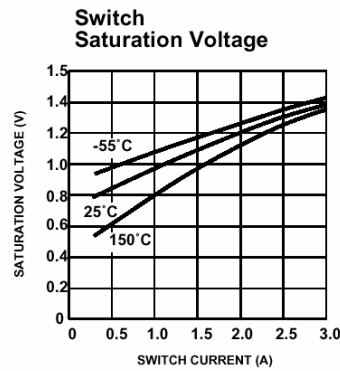
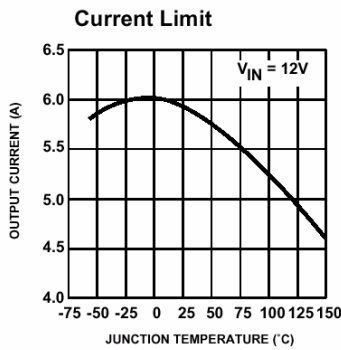
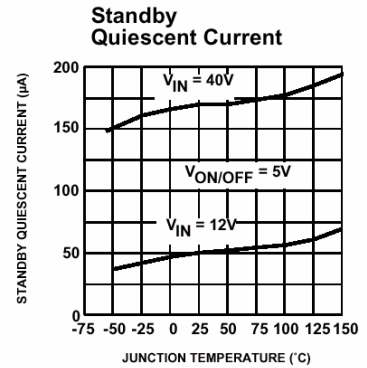
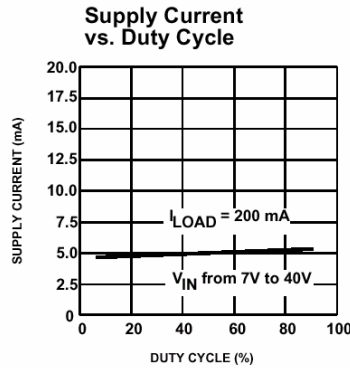
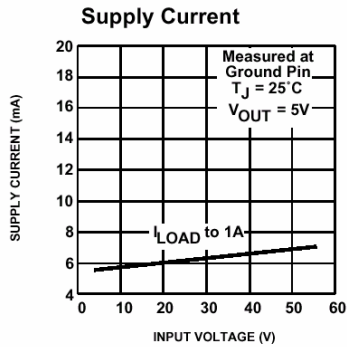

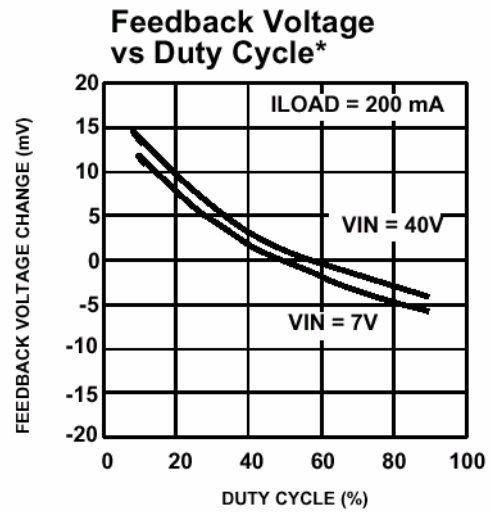
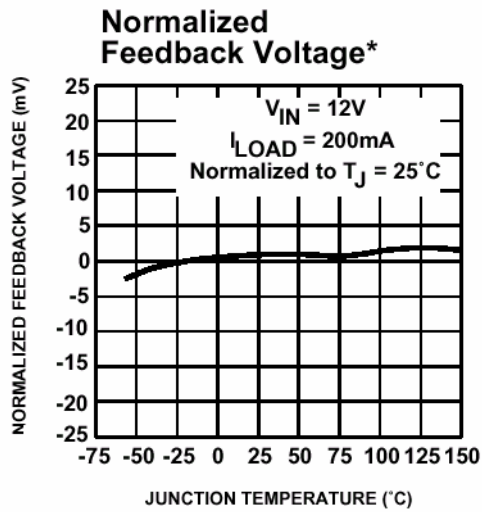

\* Adjustable version only

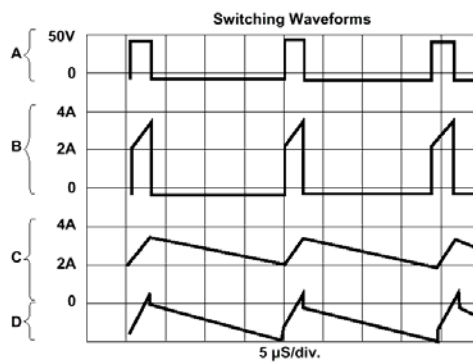
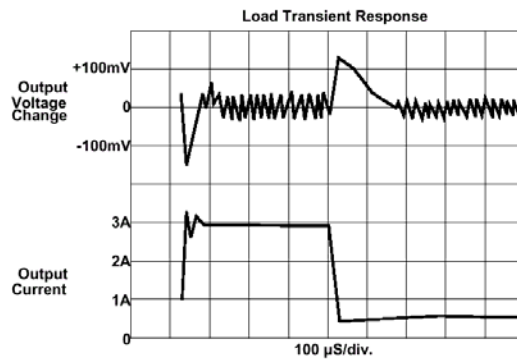

$V_{OUT} = 5V$   $V_{IN} = 45V$

A: Output pin voltage 50V/div  
 B: Output pin current 2A/div  
 C: Inductor current 2A/div  
 D: Output ripple voltage 50 mV/div., AC coupled

Horizontal Time Base: 5 $\mu S/div$

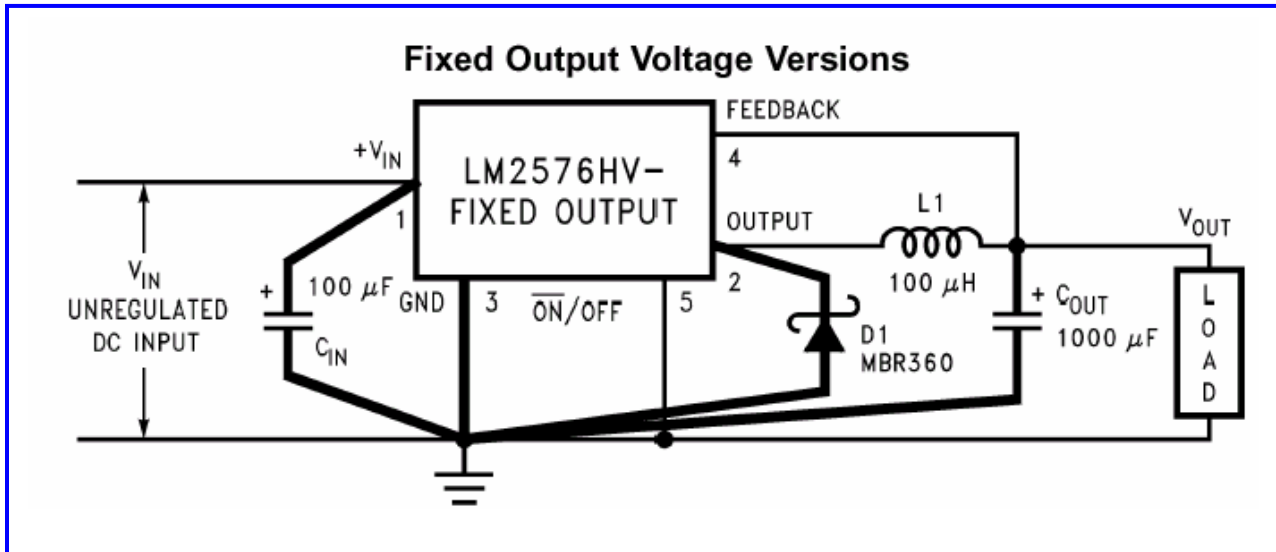

- $C_{IN}$  — 100  $\mu$ F, 75V, Aluminum Electrolytic
- $C_{OUT}$  — 1000  $\mu$ F, 25V, Aluminum Electrolytic
- $D_1$  — Schottky, MBR360
- $L_1$  — 100  $\mu$ H, Pulse Eng. PE-92108
- $R_4$  — 2k, 0.1%

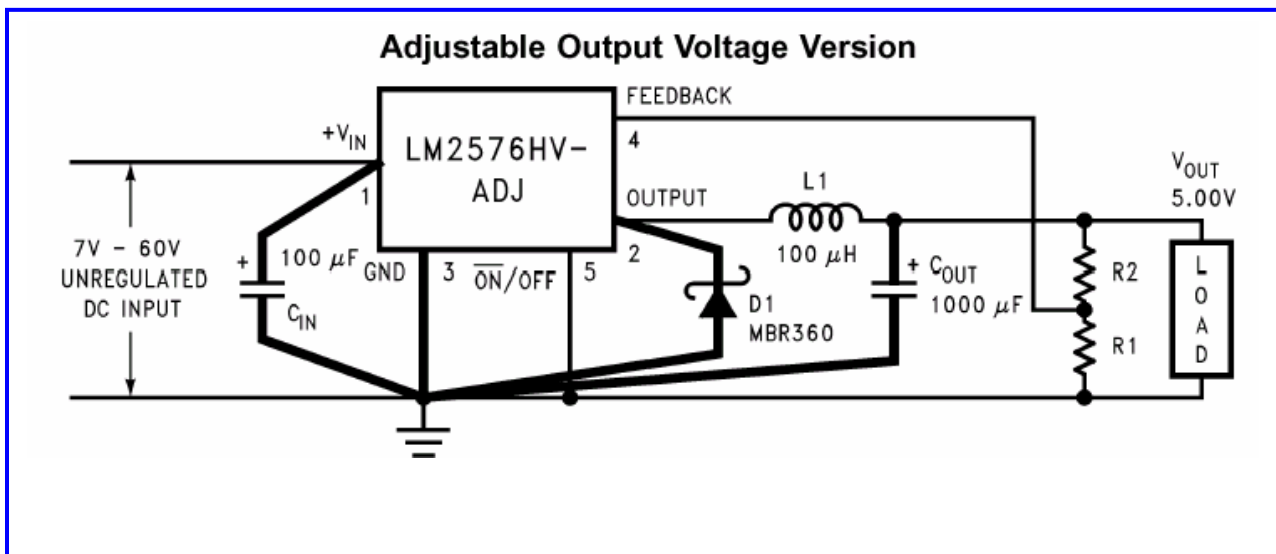

$$V_{OUT} = V_{REF} \left( 1 + \frac{R_2}{R_1} \right)$$

$$R_2 = R_1 \left( \frac{V_{OUT}}{V_{REF}} - 1 \right)$$

where  $V_{REF} = 1.23V$ ,  $R_1$  between 1k and 5k.

**Advance Information-** These data sheets contain descriptions of products that are in development. The specifications are based on the engineering calculations, computer simulations and/ or initial prototype evaluation.

**Preliminary Information-** These data sheets contain minimum and maximum specifications that are based on the initial device characterizations. These limits are subject to change upon the completion of the full characterization over the specified temperature and supply voltage ranges.

The application circuit examples are only to explain the representative applications of the devices and are not intended to guarantee any circuit design or permit any industrial property right to other rights to execute. Bay Linear takes no responsibility for any problems related to any industrial property right resulting from the use of the contents shown in the data book. Typical parameters can and do vary in different applications. Customer's technical experts must validate all operating parameters including "Typical" for each customer application.

---

#### **LIFE SUPPORT AND NUCLEAR POLICY**

---

Bay Linear products are not authorized for and should not be used within life support systems which are intended for surgical implants into the body to support or sustain life, in aircraft, space equipment, submarine, or nuclear facility applications without the specific written consent of Bay Linear President.

---